

## 2B-LS-BAND-V-X-X

### 2B-1.6-3.0-V-X-X

(1.60-2.70) GHz L/S-Band Antenna  
Avionics/Satellite Telecommunication

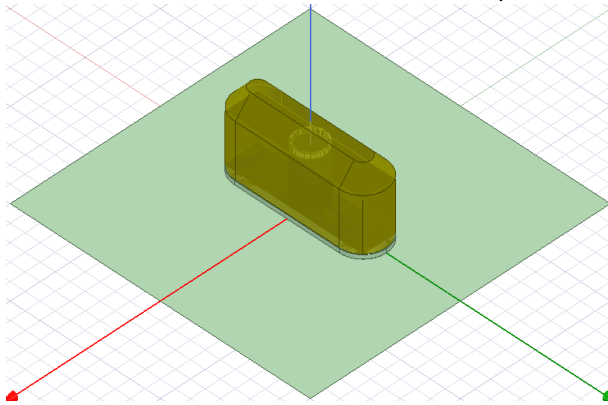

#### Electrical:

Frequency: 1.60-3.0 GHz.

Pattern: Omnidirectional

Polarization: Vertical

VSWR: 2.0:1

DC Grounding: **Yes** (Lightning Protection)

Output impedance: 50 Ohms

#### Mechanical:

Size: Width: 2.1 in, Length: 5.24 in, Height: 2.0 In.

Base plate: Aluminum

Radome: Roger (Drawing For Simulation version)

Ground plane: 12x12 inches.

**Designed : Victor Dat Do**

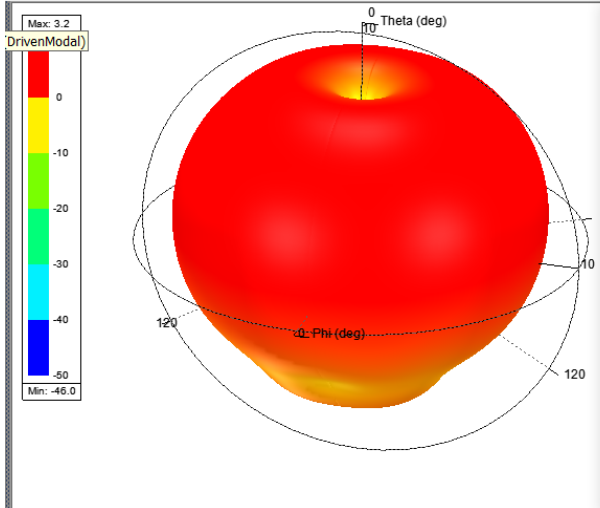
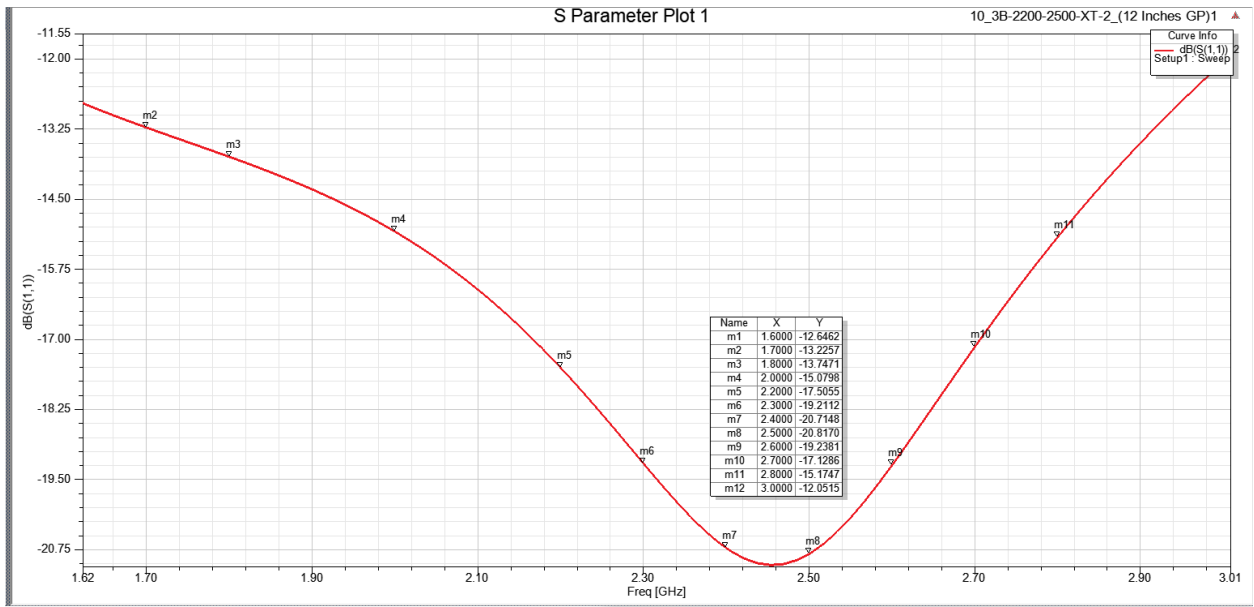

Report: 3B-800-2000\_2000-6000-XT\_Best - 10\_3B-2200-2500-XT-2\_(12 Inches GP)...

Context

Solution: Setup1 : LastAdaptive

Geometry: Infinite Sphere1

Update Report

Real time

Trace Families

Families : 1 available

Sweeps  Available variations

Variable	Value	Edit
Freq	1.6GHz	...

Nominals: |bl, bt, bw, c\_el, ch, co\_h, cr, ct|

Context

Solution: Setup1 : LastAdaptive

Geometry: Infinite Sphere1

Update Report

Real time

Output Variables... Options...

Trace Families Families Display

Families : 4 available

Sweeps  Available variations

Variable	Value	Edit
Phi	0deg, 30deg, 60deg, 90deg	...
Freq	1.6GHz	...

Nominals: |bl, bt, bw, c\_el, ch, co\_h, cr, ct|

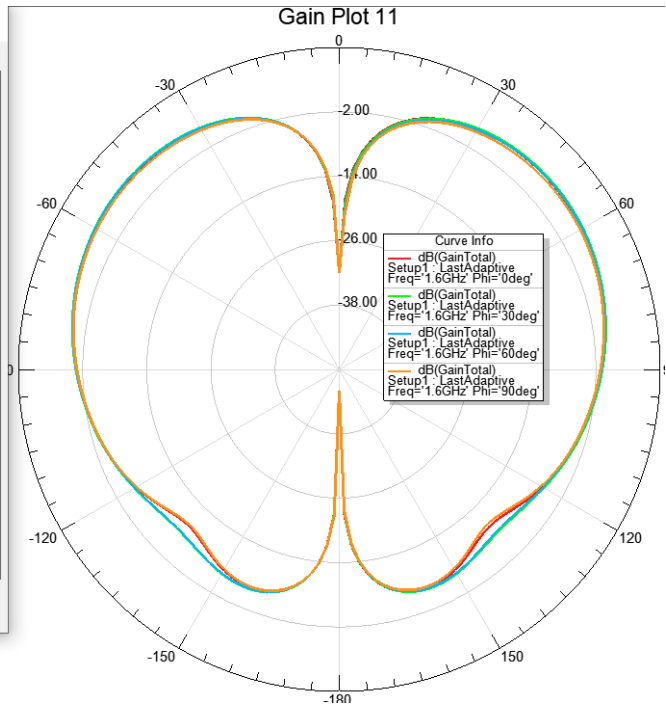

a)

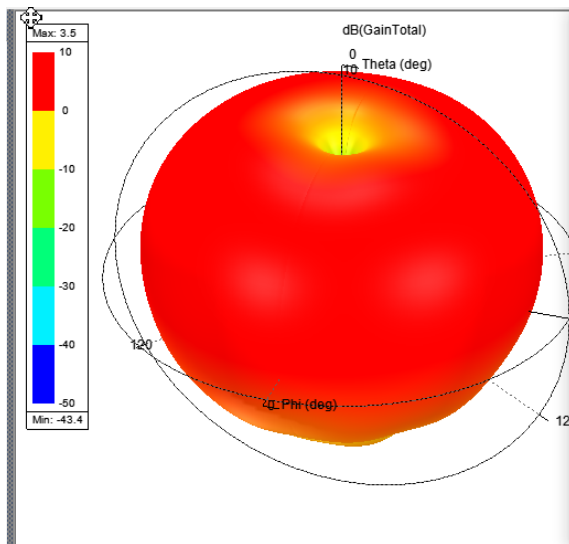

Context

Solution: Setup1 : LastAdaptive

Geometry: Infinite Sphere1

Update Report

Real time

Output Variables... Options...

Trace Families Families Display

Families : 1 available

Sweeps  Available variations

Variable	Value	Edit
Freq	2GHz	...

Nominals: |bl, bt, bw, c\_el, ch, co\_h, cr, ct|

Report: 3B-800-2000\_2000-6000-XT\_Best - 10\_3B-2200-2500-XT-2\_(12 Inches GP... X

Context  
 Solution: Setup1 : LastAdaptive  
 Geometry: Infinite Sphere1

Trace Families Families Display

Families : 4 available  
 Sweeps  Available variations

Variable	Value	Edit
Phi	0deg, 30deg, 60deg, 90deg	...
Freq	2GHz	...

Nominals: bl, bt, bw, c\_el, ch, co\_h, cr, ct

Update Report  
 Real time Update

Output Variables... Options... New Report Apply Trace Add Trace Close

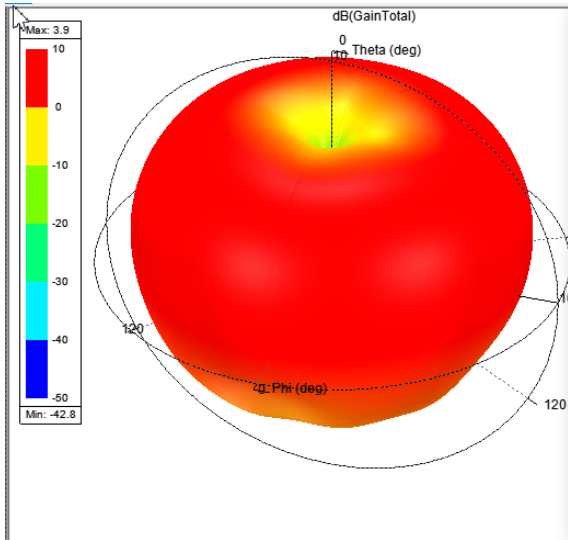
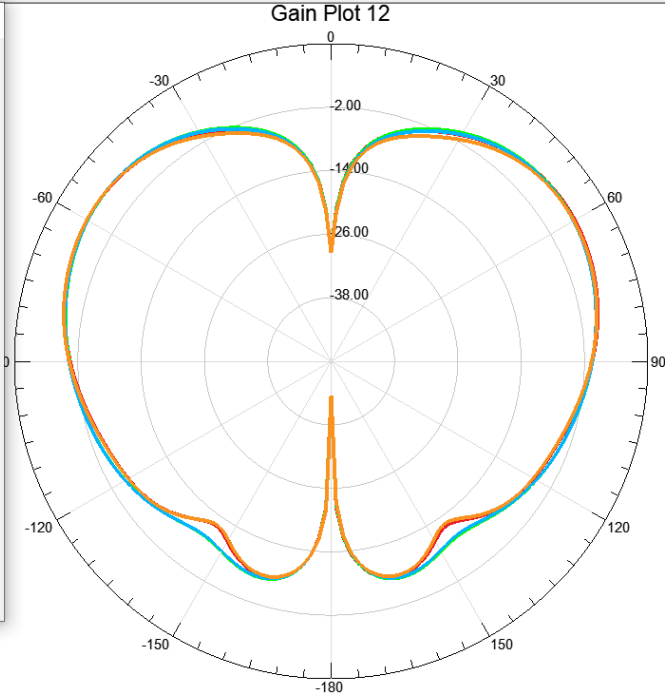

Report: 3B-800-2000\_2000-6000-XT\_Best - 10\_3B-2200-2500-XT-2\_(12 Inches GP... X

Context  
 Solution: Setup1 : LastAdaptive  
 Geometry: Infinite Sphere1

Trace Families

Families : 1 available  
 Sweeps  Available variations

Variable	Value	Edit
Freq	2.2GHz	...

Nominals: bl, bt, bw, c\_el, ch, co\_h, cr, ct

Update Report  
 Real time Update

Output Variables... Options... New Report Apply Trace Add Trace Close

Report: 3B-800-2000\_2000-6000-XT\_Best - 10\_3B-2200-2500-XT-2\_(12 Inches GP... X

Context

Solution: Setup1 : LastAdaptive

Geometry: Infinite Sphere1

Update Report

Real time

Output Variables... Options...

Trace Families Families Display

Families : 4 available

Sweeps  Available variations

Variable	Value	Edit
Phi	0deg, 30deg, 60deg, 90deg	...
Freq	2.2GHz	...

Nominals: |bl, bt, bw, c\_el, ch, co\_h, cr, ct |

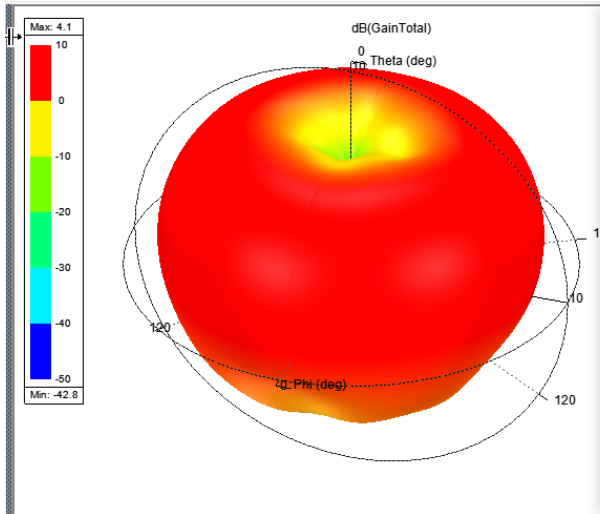
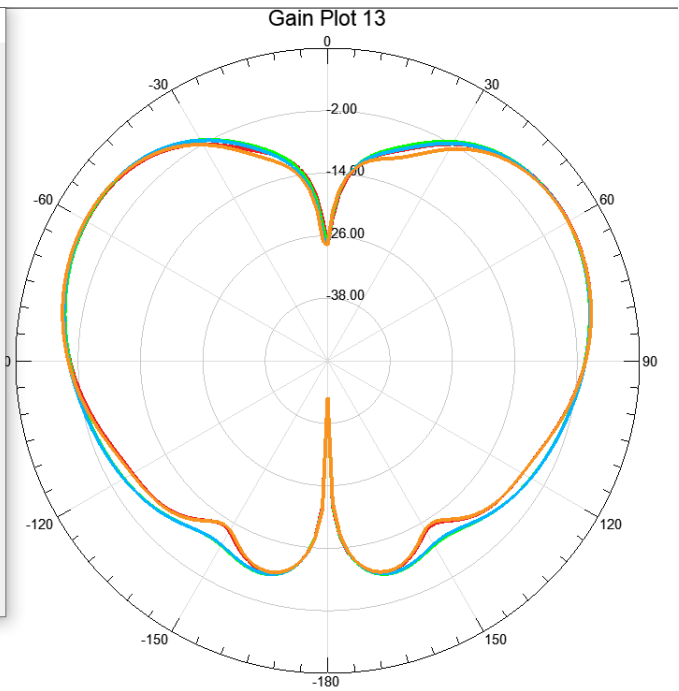

Report: 3B-800-2000\_2000-6000-XT\_Best - 10\_3B-2200-2500-XT-2\_(12 Inches GP... X

Context

Solution: Setup1 : LastAdaptive

Geometry: Infinite Sphere1

Update Report

Real time

Output Variables... Options...

Trace Families

Families : 1 available

Sweeps  Available variations

Variable	Value	Edit
Freq	2.3GHz	...

Nominals: |bl, bt, bw, c\_el, ch, co\_h, cr, ct |

Report: 3B-800-2000\_2000-6000-XT\_Best - 10\_3B-2200-2500-XT-2\_(12 Inches GP... X

Context

Solution: Setup1 : LastAdaptive

Geometry: Infinite Sphere1

Update Report

Real time

Output Variables... Options...

Trace Families Families Display

Families : 4 available

Sweeps  Available variations

Variable	Value	Edit
Phi	0deg, 30deg, 60deg, 90deg	...
Freq	2.3GHz	...

Nominals: bl, bt, bw, c\_el, ch, co\_h, cr, ct

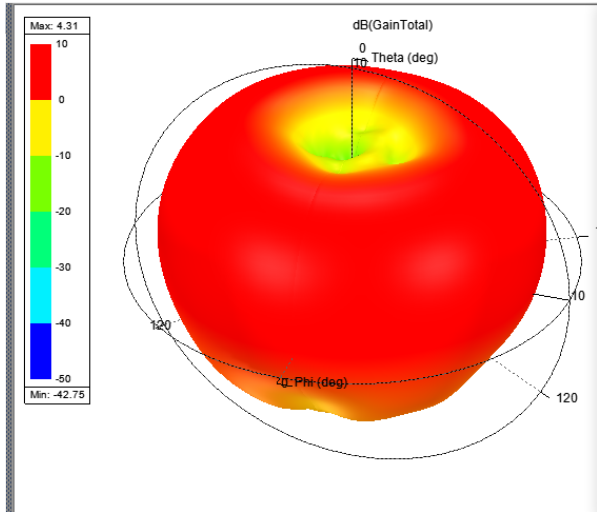
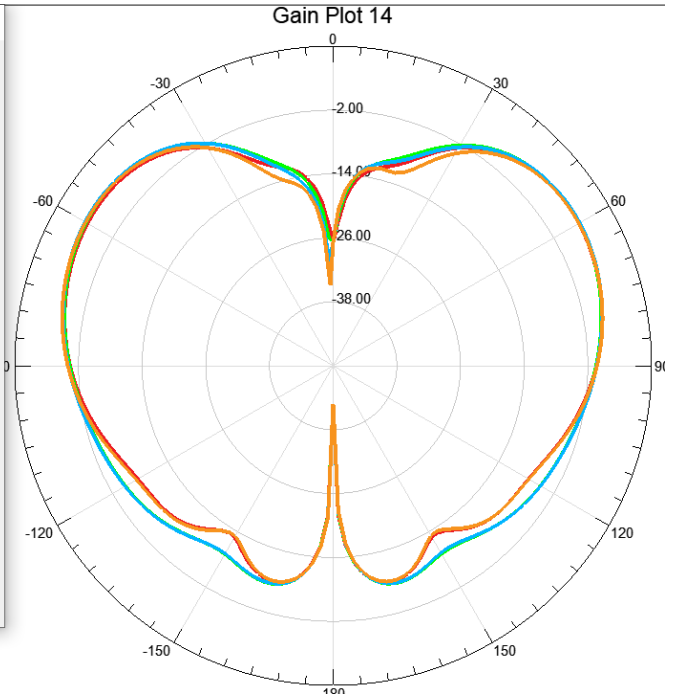

Report: 3B-800-2000\_2000-6000-XT\_Best - 10\_3B-2200-2500-XT-2\_(12 Inches GP... X

Context

Solution: Setup1 : LastAdaptive

Geometry: Infinite Sphere1

Update Report

Real time

Output Variables... Options...

Trace Families

Families : 1 available

Sweeps  Available variations

Variable	Value	Edit
Freq	2.4GHz	...

Nominals: bl, bt, bw, c\_el, ch, co\_h, cr, ct

Report: 3B-800-2000\_2000-6000-XT\_Best - 10\_3B-2200-2500-XT-2\_(12 Inches GP... X

Context

Solution: Setup1 : LastAdaptive

Geometry: Infinite Sphere1

Update Report

Real time

Output Variables... Options...

Trace Families Families Display

Families : 4 available

Sweeps  Available variations

Variable	Value	Edit
Phi	0deg, 30deg, 60deg, 90deg	...
Freq	2.4GHz	...

Nominals: | bl, bt, bw, c\_el, ch, co\_h, cr, ct |

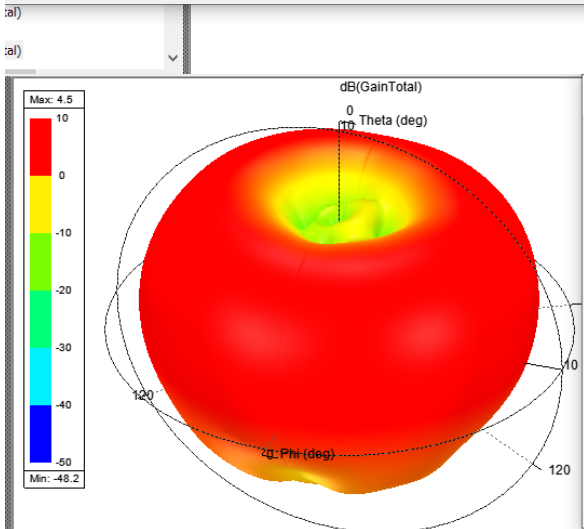
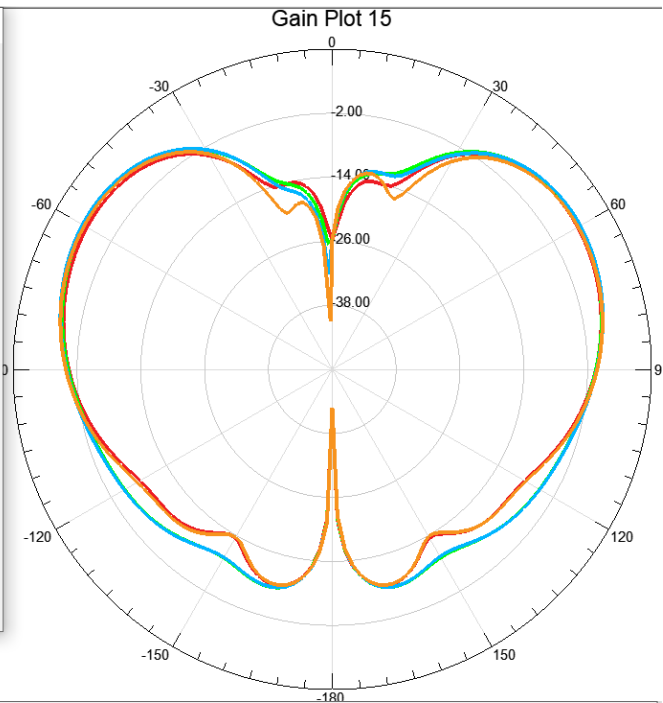

Report: 3B-800-2000\_2000-6000-XT\_Best - 10\_3B-2200-2500-XT-2\_(12 Inches GP... X

Context

Solution: Setup1 : LastAdaptive

Geometry: Infinite Sphere1

Update Report

Real time

Output Variables... Options...

Trace Families

Families : 1 available

Sweeps  Available variations

Variable	Value	Edit
Freq	2.5GHz	...

Nominals: | bl, bt, bw, c\_el, ch, co\_h, cr, ct |

Report: 3B-800-2000\_2000-6000-XT\_Best - 10\_3B-2200-2500-XT-2\_(12 Inches GP... X

Context

Solution: Setup1 : LastAdaptive

Geometry: Infinite Sphere1

Update Report

Real time

Output Variables... Options...

Trace Families Families Display

Families : 4 available

Sweeps  Available variations

Variable	Value	Edit
Phi	0deg, 30deg, 60deg, 90deg ...	...
Freq	2.5GHz	...

Nominals: |bl, bt, bw, c\_el, ch, co\_h, cr, ct |

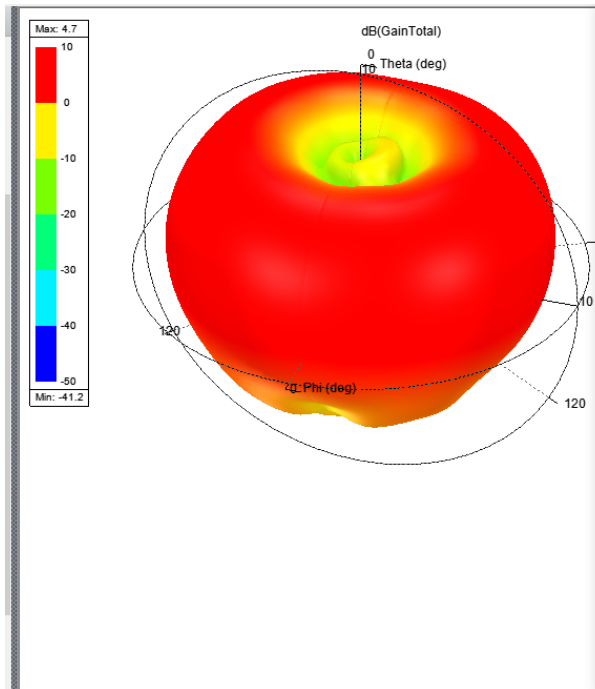
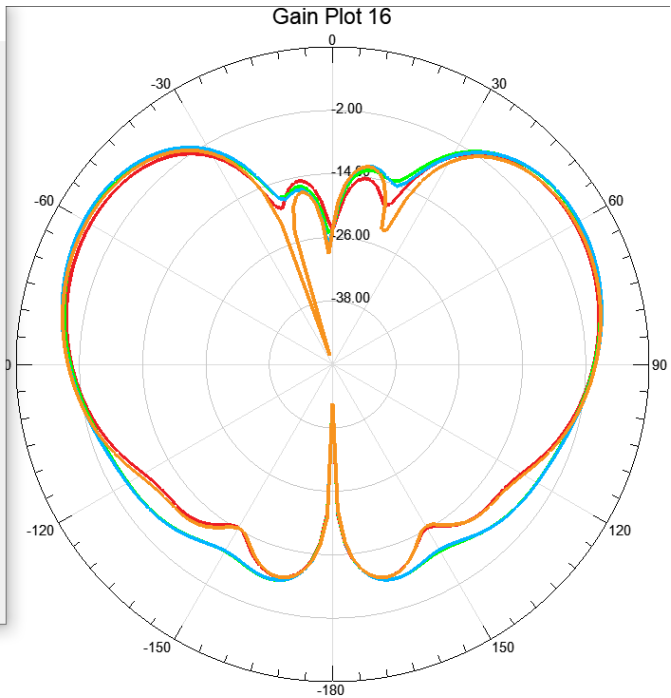

Report: 3B-800-2000\_2000-6000-XT\_Best - 10\_3B-2200-2500-XT-2\_(12 Inches GP... X

Context

Solution: Setup1 : LastAdaptive

Geometry: Infinite Sphere1

Update Report

Real time

Output Variables... Options...

Trace Families

Families : 1 available

Sweeps  Available variations

Variable	Value	Edit
Freq	2.6GHz	...

Nominals: |bl, bt, bw, c\_el, ch, co\_h, cr, ct |



Report: 3B-800-2000\_2000-6000-XT\_Best - 10\_3B-2200-2500-XT-2\_(12 Inches GP... X

Context

Solution: Setup1 : LastAdaptive

Geometry: Infinite Sphere1

Update Report

Real time

Output Variables... Options...

Trace Families Families Display

Families : 4 available

Sweeps  Available variations

Variable	Value	Edit
Phi	0deg, 30deg, 60deg, 90deg	...
Freq	2.6GHz	...

Nominals: |bl, bt, bw, c\_el, ch, co\_h, cr, ct |

Gain Plot 5

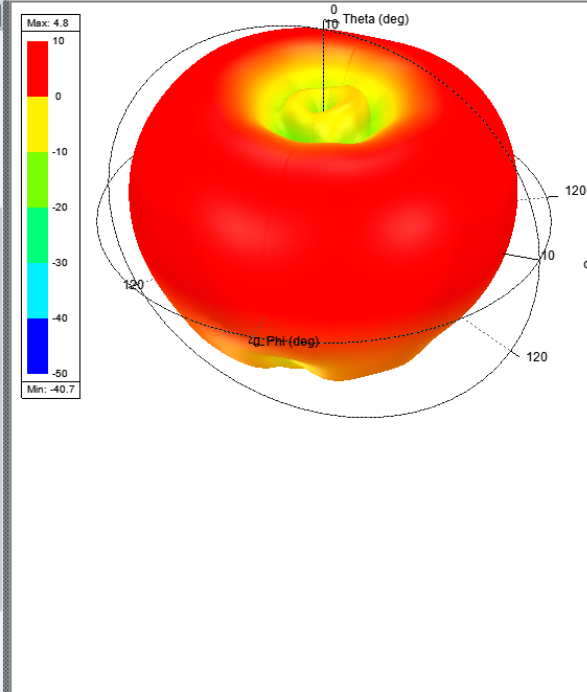
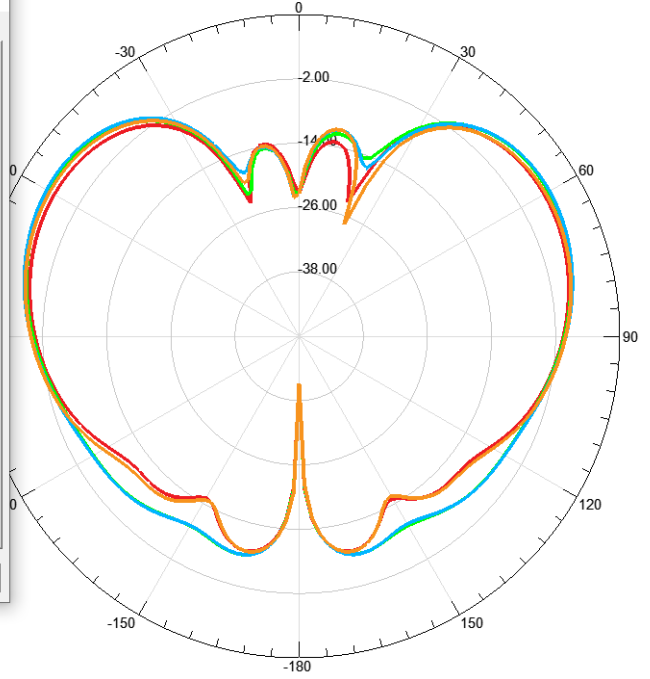

Report: 3B-800-2000\_2000-6000-XT\_Best - 10\_3B-2200-2500-XT-2\_(12 Inches GP... X

Context

Solution: Setup1 : LastAdaptive

Geometry: Infinite Sphere1

Update Report

Real time

Output Variables... Options...

Trace Families

Families : 1 available

Sweeps  Available variations

Variable	Value	Edit
Freq	2.7GHz	...

Nominals: |bl, bt, bw, c\_el, ch, co\_h, cr, ct |

Report: 3B-800-2000\_2000-6000-XT\_Best - 10\_3B-2200-2500-XT-2\_(12 Inches GP... X

Context  
 Solution: Setup1 : LastAdaptive  
 Geometry: Infinite Sphere1

Trace Families Families Display |

Families : 4 available  
 Sweeps  Available variations

Variable	Value	Edit
Phi	0deg, 30deg, 60deg, 90deg ...	...
Freq	2.7GHz	...

Nominals: | bl, bt, bw, c\_el, ch, co\_h, cr, ct |

Update Report  
 Real time Update

Output Variables... Options... New Report Apply Trace Add Trace Close

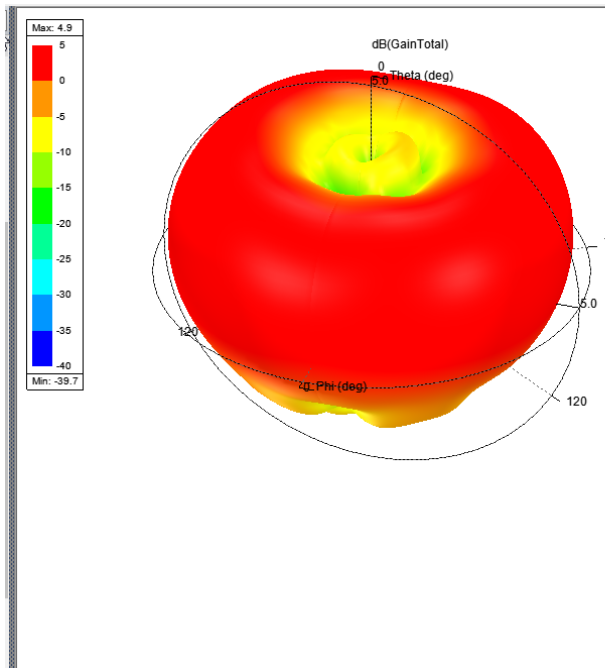
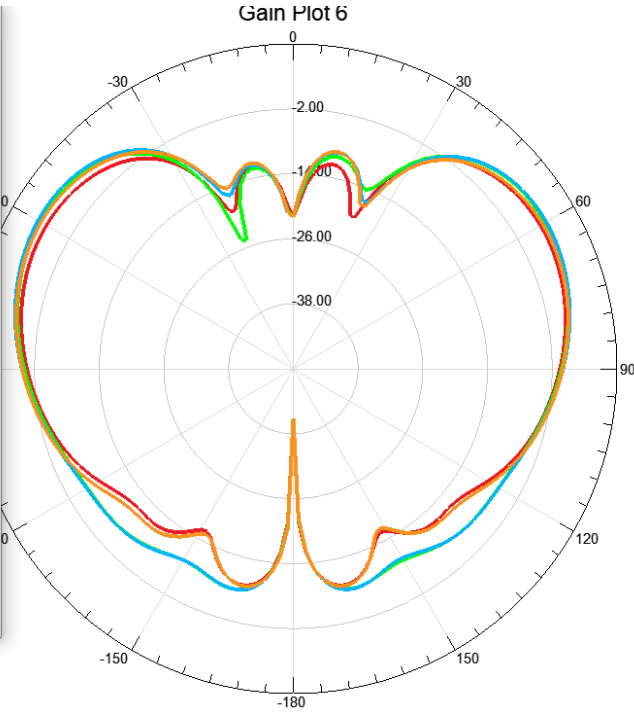

Report: 3B-800-2000\_2000-6000-XT\_Best - 10\_3B-2200-2500-XT-2\_(12 Inches GP... X

Context  
 Solution: Setup1 : LastAdaptive  
 Geometry: Infinite Sphere1

Trace Families Families Display |

Families : 1 available  
 Sweeps  Available variations

Variable	Value	Edit
Freq	2.8GHz	...

Nominals: | bl, bt, bw, c\_el, ch, co\_h, cr, ct |

Update Report  
 Real time Update

Output Variables... Options... New Report Apply Trace Add Trace Close

Report: 3B-800-2000\_2000-6000-XT\_Best - 10\_3B-2200-2500-XT-2\_(12 Inches GP... X

Context  
 Solution: Setup1 : LastAdaptive  
 Geometry: Infinite Sphere1

Trace Families Families Display

Families : 4 available  
 Sweeps  Available variations

Variable	Value	Edit
Phi	0deg, 30deg, 60deg, 90deg	...
Freq	2.8GHz	...

Nominals: bl, bt, bw, c\_el, ch, co\_h, cr, ct

Update Report  
 Real time Update

Output Variables... Options... New Report Apply Trace Add Trace Close

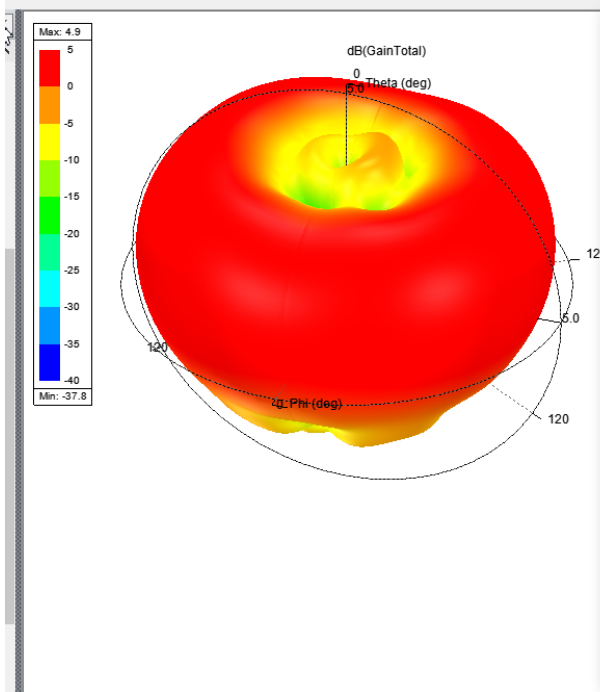
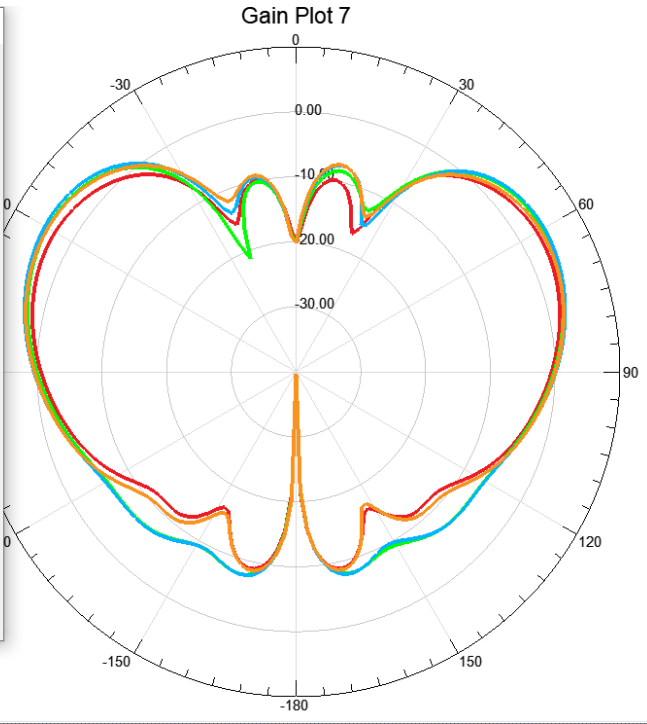

Report: 3B-800-2000\_2000-6000-XT\_Best - 10\_3B-2200-2500-XT-2\_(12 Inches GP... X

Context  
 Solution: Setup1 : LastAdaptive  
 Geometry: Infinite Sphere1

Trace Families

Families : 1 available  
 Sweeps  Available variations

Variable	Value	Edit
Freq	2.9GHz	...

Nominals: bl, bt, bw, c\_el, ch, co\_h, cr, ct

Update Report  
 Real time Update

Output Variables... Options... New Report Apply Trace Add Trace Close

Report: 3B-800-2000\_2000-6000-XT\_Best - 10\_3B-2200-2500-XT-2\_(12 Inches GP... X

Context  
 Solution: Setup1 : LastAdaptive  
 Geometry: Infinite Sphere1

Trace Families Families Display

Families : 4 available

Sweeps  Available variations

Variable	Value	Edit
Phi	0deg, 30deg, 60deg, 90deg	...
Freq	2.9GHz	...

Nominals: bl, bt, bw, c\_el, ch, co\_h, cr, ct

Update Report  
 Real time Update

Output Variables... Options... New Report Apply Trace Add Trace Close

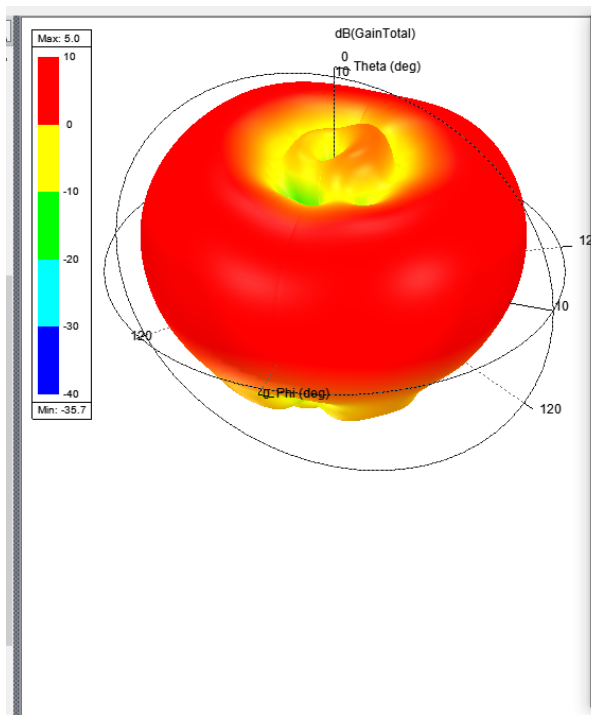
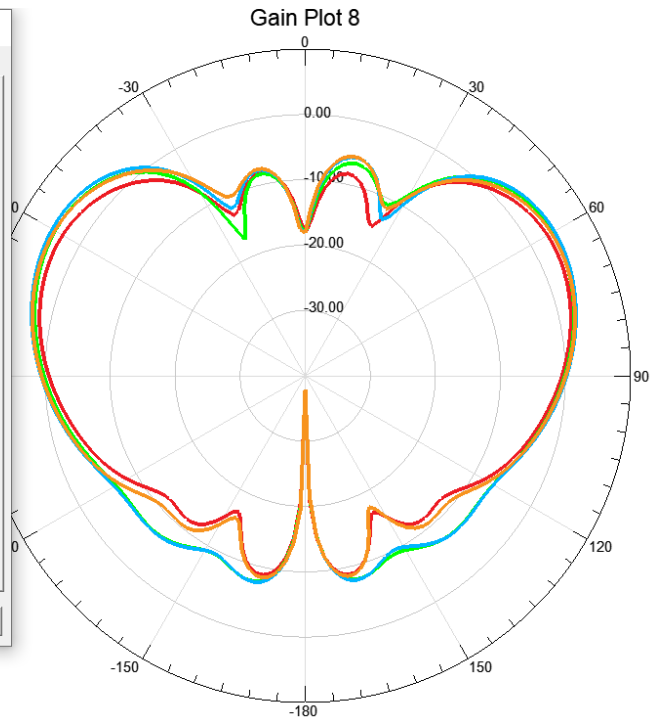

Report: 3B-800-2000\_2000-6000-XT\_Best - 10\_3B-2200-2500-XT-2\_(12 Inches GP... X

Context  
 Solution: Setup1 : LastAdaptive  
 Geometry: Infinite Sphere1

Trace Families

Families : 1 available

Sweeps  Available variations

Variable	Value	Edit
Freq	3GHz	...

Nominals: bl, bt, bw, c\_el, ch, co\_h, cr, ct

Update Report  
 Real time Update

Output Variables... Options... New Report Apply Trace Add Trace Close

Report: 3B-800-2000\_2000-6000-XT\_Best - 10\_3B-2200-2500-XT-2\_(12 Inches GP... X

Context

Solution: Setup1 : LastAdaptive

Geometry: Infinite Sphere1

Update Report

Real time

Output Variables... Options...

Trace Families Families Display

Families : 4 available

Sweeps  Available variations

Variable	Value	Edit
Phi	0deg, 30deg, 60deg, 90deg	...
Freq	3GHz	...

Nominals: bl, bt, bw, c\_el, ch, co\_h, cr, ct

